

90CM HEADEND AND FOOTEND

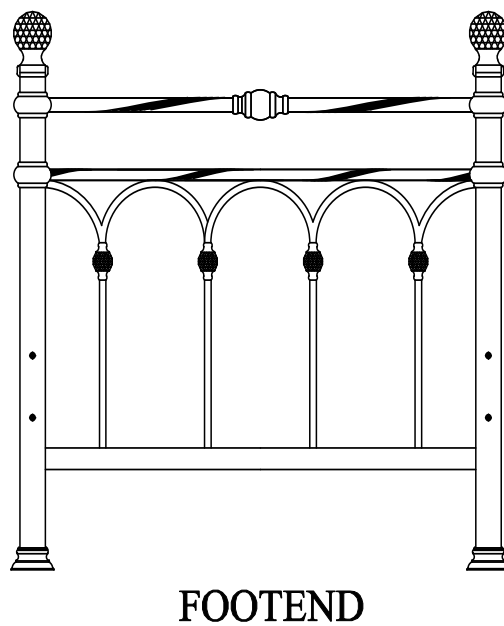

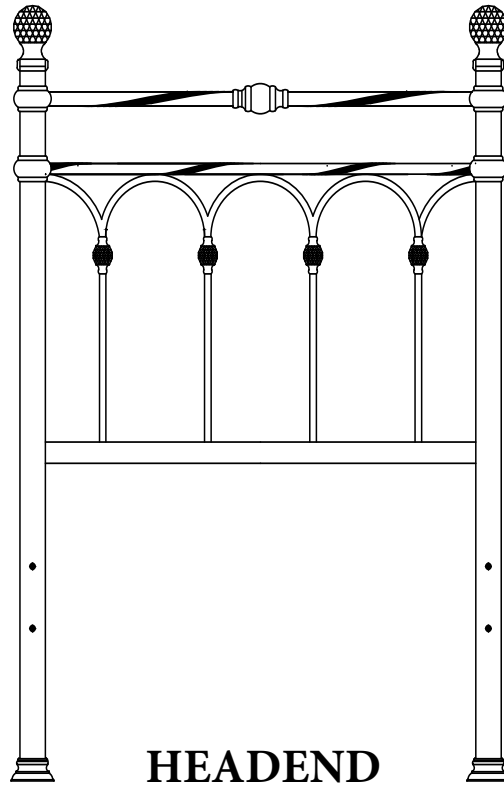

Stock number: 2459B, 2469B, M1970B-90, M1980B-90

Thank you for purchasing this product. Please read the instruction carefully before use to ensure safe and satisfactory operation of this product.

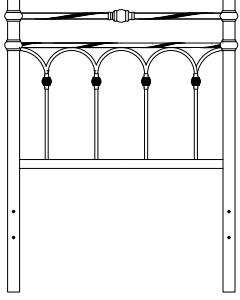
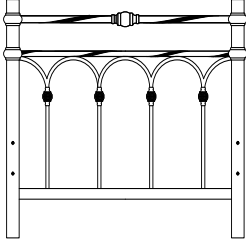
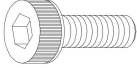

90CM HEADEND AND FOOTEND

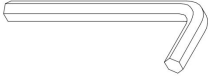
Fittings and parts checklist

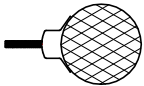
Item	Description	Sketch	Qty
1	HEADEND		1pc
2	FOOTEND		1pc
3	8mm Allen Bol ts		8pcs
4	FLAT WASHER		8pcs
5	8mm PLASTIC PAD		8pcs
6	Allen Wrench		1pc
7	METAL CONNECTOR		4pcs
8	BUN FOOT		4pcs
8	TOP FINIAL		4pcs

90CM HEADEND AND FOOTEND

Step 1

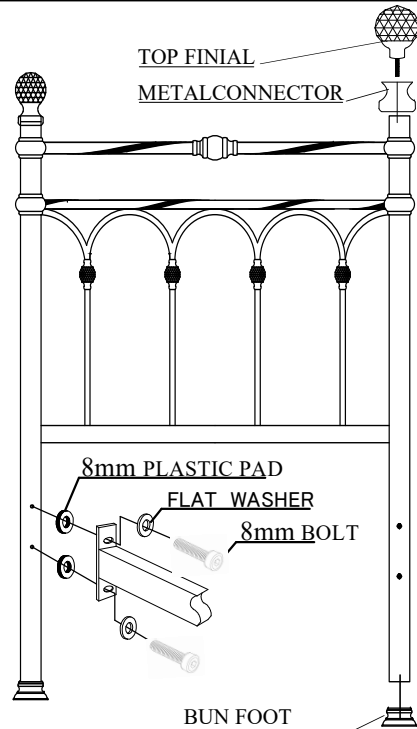

Step 2

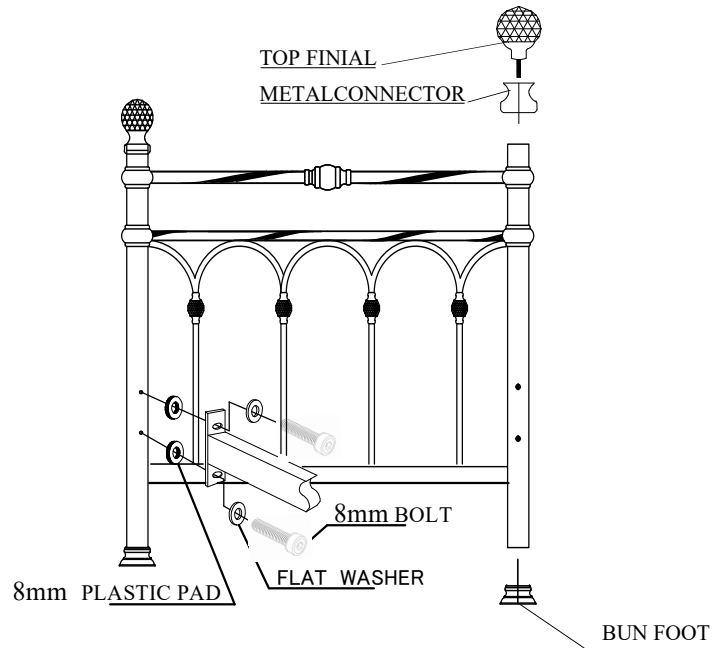

CARE OF YOUR BEDSTEAD

- Use a soft dry duster to clean your plated bedstead
- For stubborn stains, use a soft damp cloth and then revert to the soft dry duster
- PLEASE NOTE : Polishing materials and solvents should not be used, as they dissolve the protecting lacquer and allow oxidation of the genuine base material.
- Using fittings in the incorrect place when assembling the bedstead can cause fittings to become cross threaded. This can then lead to fittings becoming trapped; making disassembly of the product difficult and voiding the warranty. Please take care to ensure all fittings are used only where stipulated.

We cannot accept responsibility for damage caused due to misuse of this product.